

CHIAROSCURO

Specialists in shutter Automation

Catalogue

SL120



REL. 20.11.23

· CHIARO SCURO ·

Dear Customer,

We are excited to present you with our brand new CATALOGUE for 2024-2025.

For more than a quarter of a century, CHIAROSCURO has been synonymous with excellence in mechatronic solutions for shutter automation. We are known for developing dynamic, integrated solutions with unique, patented features.

Our success is based on products that are reliable, easy to install and designed to last. All of this is made entirely in Italy. We are proud to have served our customers for 25 years, constantly adapting our automations to new technologies and integrating them easily into any home automation system. You can conveniently control our automations via radio remote control, home automation or push-button control, simplifying your daily life. Our range of automations can be easily integrated into home automation systems.

We strongly support Made in Italy. All our mechanical components are made in Italy, the electronic boards are assembled in Italy and the electric motors are of Italian origin. We collaborate with local suppliers rooted in Italy.

Ecology is at the centre of our attention: we use eco-friendly materials, eco-friendly packaging and environmentally friendly production processes.

We continue to invest in improving the quality of our products, using state-of-the-art machinery and mechanical components made of solid steel at our CS Meccanica division.

With CHIAROSCURO, you can automate sliding or hinged shutters of any type, whether new or already installed. We offer a complete range of automations, each designed to address specific needs. This variety of solutions allows the automations to integrate optimally with any type of shutter, ensuring maximum efficiency in movement.

We are ready to make your life more comfortable and secure with our automation solutions. We hope that our catalogue will inspire and guide you in choosing the perfect solutions for your needs.

We thank you for your continued trust in CHIAROSCURO.



ST50: Quiet, powerful and easy

Designed to be durable, easy to use and to install, with a practical and essential aesthetic, ST-50 combines silence with high performance. This automation is available in ceiling or recessed mounted installation.



ST50MA: The shoulder mounted automation

All ST-50 features of performance and silence, concealed within the window shoulder. It combines a minimalistic design to an intuitive and practical use.



ST50EM: The Universal Automation

This iteration of ST50 is designed to automate shutters in those contexts where confined spaces do not allow the adoption of traditional solutions. The reliable ST50 mechanical base that guarantees high performance in absolute silence, in a compact and tasteful casing above the window.



WH25: Concealed Hinge Automation

This fully concealed automation guarantees an absolutely invisible aesthetic impact, ensuring an elegant and classy installation. The sturdy mechanics secures smooth operations of the sashes even in the absence of articulations.

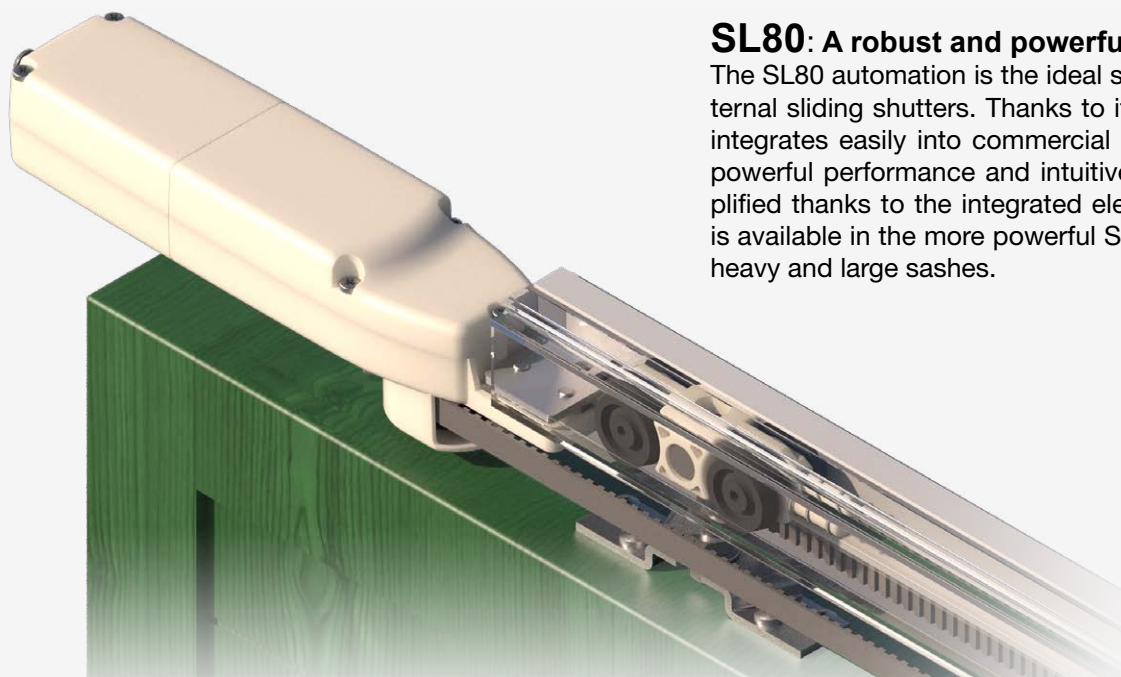
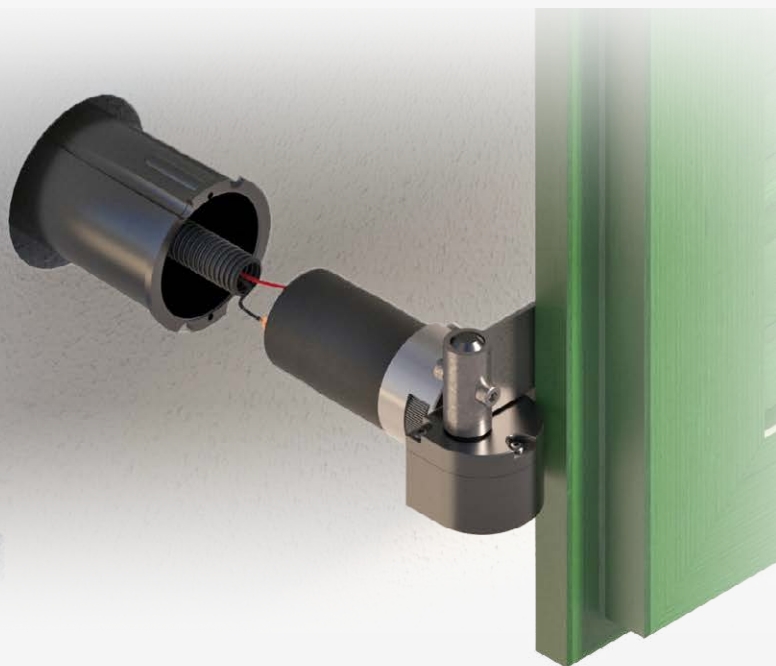

SL80: A robust and powerful automation

The SL80 automation is the ideal solution for automating external sliding shutters. Thanks to its low profile of 38 mm, it integrates easily into commercial sliding mechanisms. With powerful performance and intuitive use, even wiring is simplified thanks to the integrated electronics. This automation is available in the more powerful SL100 version, for handling heavy and large sashes.

SL120: The Concealed Sliding Door Automation

Its compact vertical body integrates easily into boxes with pull-out track. It can be inspected thanks to numerous quick-release solutions for the track, which are also designed for existing shutters. High power and silent operation allow easy handling of heavy and large sashes

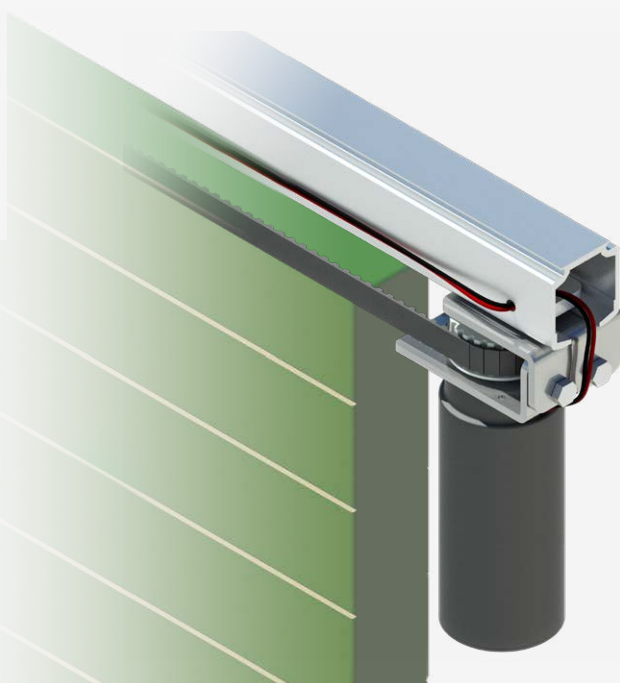

Our mechanical production division and engineering department

In 2019, brothers and partners Marco and Luca Girelli made a crucial decision for the future of the company. They chose to further invest in the growth of the company, enhancing the mechanical production division with new machinery and highly qualified personnel.

The goal was to internally manage all mechanical production processes, ensuring scrupulous control of the production process and at the same time increasing the quality of the products, while maintaining the typical agility of artisanal production. This commitment testifies to the company's constant desire to grow and innovate, generating a generational leap that has led to an increase in product quality and has created new job opportunities in the area for highly qualified personnel.

The introduction of cutting-edge machinery has opened up new and promising opportunities for CHIAROSCURO, demonstrating the willingness to invest even in economically complex periods, when many other companies remain cautious and stagnant. This choice represents a deep confidence in their own abilities, a testimony of faith in the company and its strength, and the conviction that the sector of automation for shutters, in general, will continue to grow both in the present and in the future. Thanks to the adoption of cutting-edge machinery, CS Meccanica is able to offer extremely precise and rapid turning and milling services. We specialize in producing components to customer specifications, and our passion, quality, and precision guide our evolution. We know that everything we produce contributes to making our customers more competitive. Our areas of expertise include the production of components with technologies up to 5 continuous axes. We work with a wide range of materials and confidently accept challenges of all kinds.

CS Meccanica is a brand of CHIAROSCURO SAS.

The company's growth in its reference sector, along with the new production capabilities of CS Meccanica, has led to a vertical development of the products and skills offered. The investment has not been limited to machinery alone, but has also extended to software. We now use a complete Autodesk suite, which includes Autocad, Inventor Professional, 3D Studio Max, Fusion 360, and many other tools optimized for Inventor, such as Nastran In-CAD, HSM, Nesting Utility, and many others. Additionally, our staff is highly qualified and constantly updated.

Our engineering department plays a key role for CHIAROSCURO, managing the mechanical engineering and design services necessary to develop and produce our products. The team is young and dynamic, which allows us to achieve the best results in the shortest possible time. The speed and precision in the production of components translate into greater control, savings, and total reliability of the products produced. Furthermore, thanks to OpenMind's CAM Hypermill software, we are able to produce extremely complex components with continuous 5-axis milling operations.



Our fleet

We are proud to present our mechanical production department, located in an area of 900 sqm, entirely dedicated to metal cutting machining

Lathe Department



Doosan Lynx 2100 LYA 5 axis CNC lathe

- 16 Motorized Tools
- MT hob holder for gear production
- Hydraulic CNC tailstock
- Doosan control - Fancuc i-series
- Turnable diameter: 300/236 mm.
- Max turning length 510mm.

Machining Center



Doosan DNM 4500 Vertical 4-axis machining center

- Continuous 4th axis rotating table
- Rotating table for hydraulic locking
- Continuous 4th axis roto-translation module
- Rotation speed 12,000 rpm
- X axis travel 800 mm.
- Y axis travel 450 mm.
- Z axis travel 510 mm.



Doosan VC630 Continuous 5-axis vertical machining center

- Heidenhain Tnc 640 control
- 40 tools
- Rotation speed 12,000 rpm
- X axis travel 650 mm.
- Y axis travel 765 mm.
- Z axis travel 520 mm.



Awea AF1060 Vertical 3-axis machining center

- Spindle rotation speed 15,000 rpm
- X axis travel 1060 mm.
- Y axis travel 600 mm.
- Z axis travel 600 mm.
- Table diam. 1200x600 mm

Process Control



Blum Probe

Quality control directly in the machine thanks to a compact 3D contact system.

SL120 – Recessed sliding shutter automation

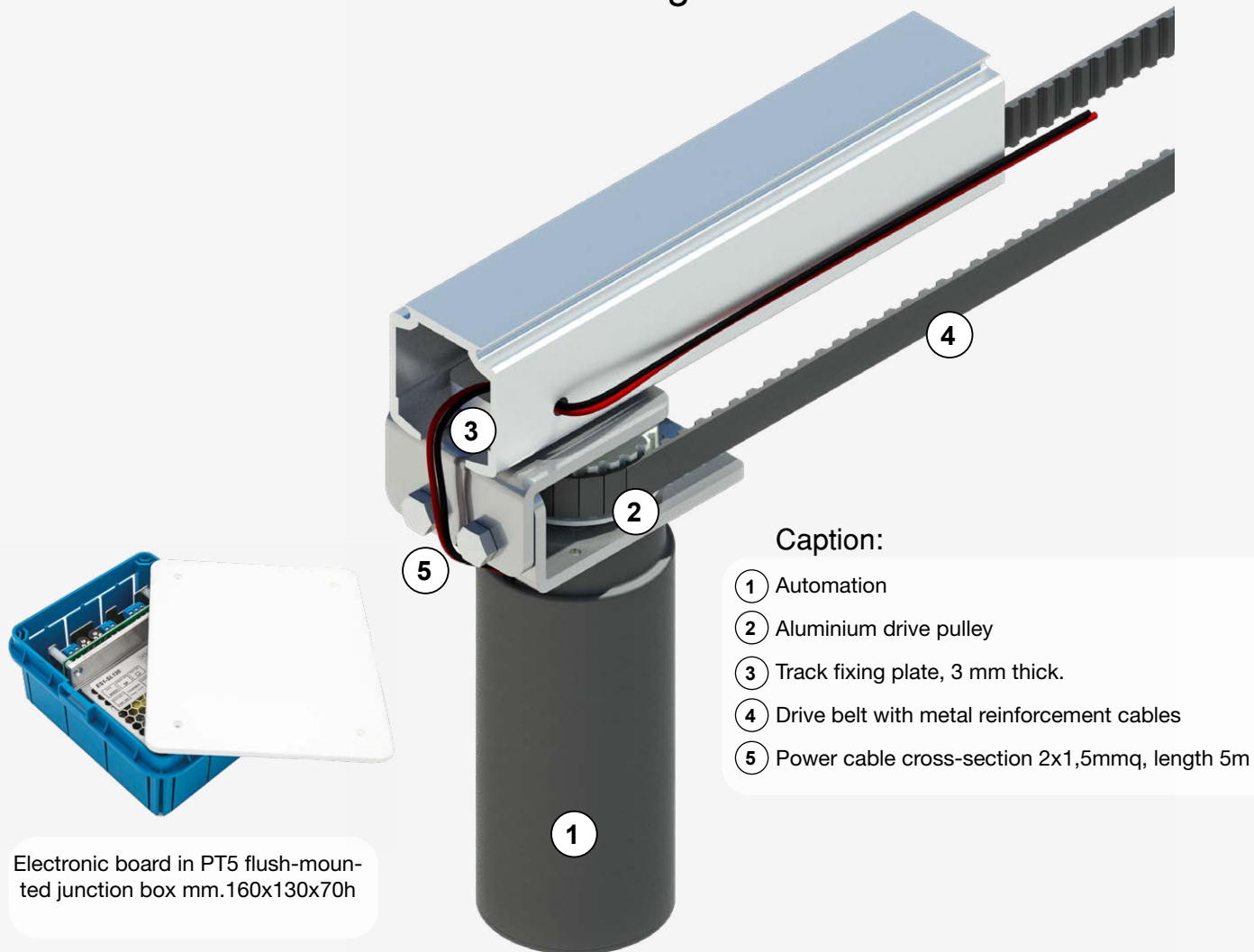

Electronic board in PT5 flush-mounted junction box mm.160x130x70h

Caption:

- ① Automation
- ② Aluminium drive pulley
- ③ Track fixing plate, 3 mm thick.
- ④ Drive belt with metal reinforcement cables
- ⑤ Power cable cross-section 2x1,5mmq, length 5m



Ultra Compact:

Applicable in counterframes for concealed doors with a minimum internal compartment of 6cm. and with a pull-out track. Occupies only 8cm. at the bottom of the box.



Safe:

Reversible automation allows operation even in the absence of power. Increased safety with optional electronic brake.



Practical:

Thanks to its small footprint and external PT5 box control unit, the automation can also be adapted to existing boxes with pull-out track.



Total home automation compatibility:

Automation compatible with all home automation systems without the need for additional interfaces. It connects to the electrical system like a normal roller shutter motor, combining the simplicity of connection with the convenience of home automation functions typical of roller shutter modules.

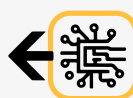

Separate electronic board:

Motion control unit that can be perfectly interfaced with all home automation systems. It meets safety requirements in the event of an impact, and the force and speed can be adjusted. Comes in a compact and practical PT5 junction box to be placed inside the home.



Certified:

Product for professional use, CE-certified, complying with European directives and standards for free installation.



Made In Italy:

100% of components are made in Italy.



Warranty:

2 Years.

SL120 - Data sheet

Caption:

- 1 Automation
- 2 Aluminium drive pulley
- 3 Track fixing plate, 3 mm thick
- 4 Drive belt with metal reinforcement cables
- 5 Power cable cross-section 2x1,5mmq, length 5m
- 6 Side-mounted tractor plate
- 7 External electronics in PT5 junction box

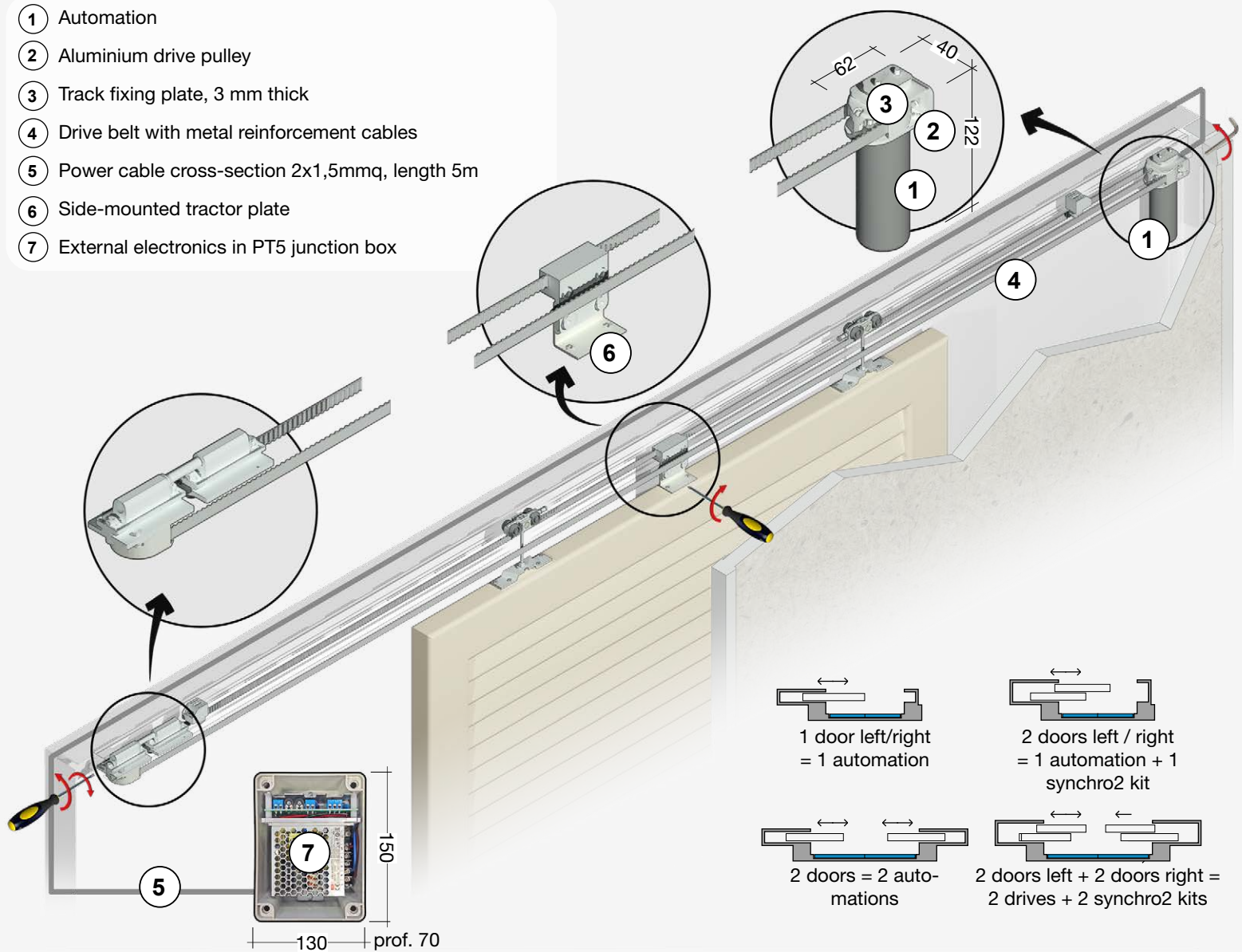

Model	SL120i.1A	SL120i.2A
Number of doors	1	2
Min-max width 1 door	40 - 350 cm	
Min-max width 2 sashes	80 - 700 cm	
Max. weight 1 sash or sum of several sashes	200 Kg. mm. 120 x 62.7 x 40	
Dimensions LxHxD	110 ÷ 230 Vac	
Electronic board power supply	24 Vdc	
Automation power supply	0,3 A	
Maximum current consumption	< 150 N	
Obstacle detection impact force	120 N	
Maximum pushing and pulling force	90 mm/sec	
Maximum movement speed	20 cycles/hour	
Working cycle	Position self-determination	
Limit switch adjustment	in PT5 box 160x130x70	
Separate electronic card	Standard	
Reversible pulley	6 metres	
Standard belt length	6 metres	
Cable length	Yes on request	

Integrated radio receiver

SL120 - Application fields - cable outlet arrangements

Caption:

- ① Automation
- ② Return pulley
- ③ Door

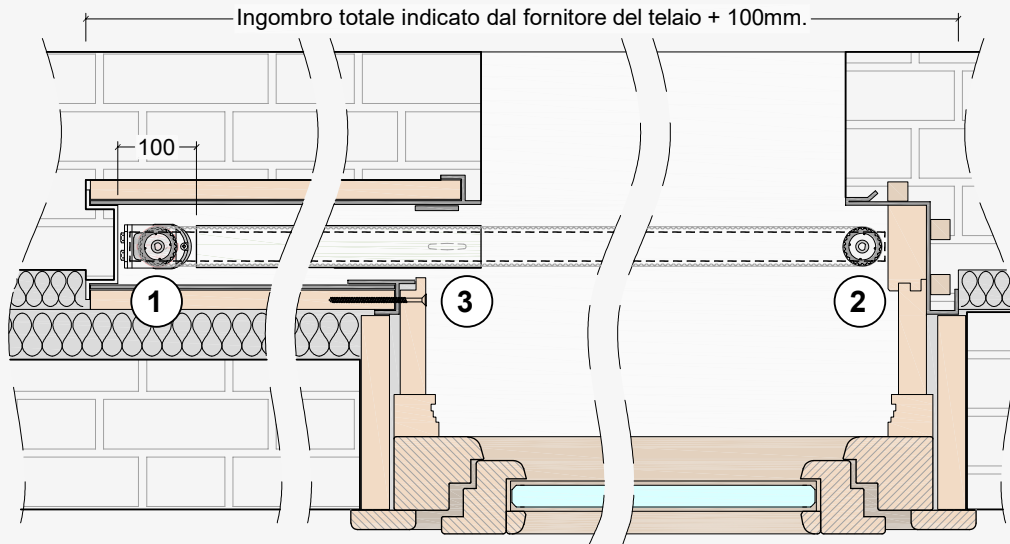
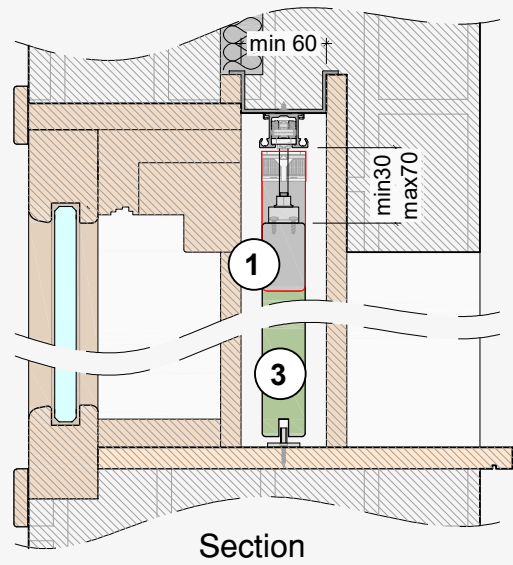

Application on single-door sliding counterframe

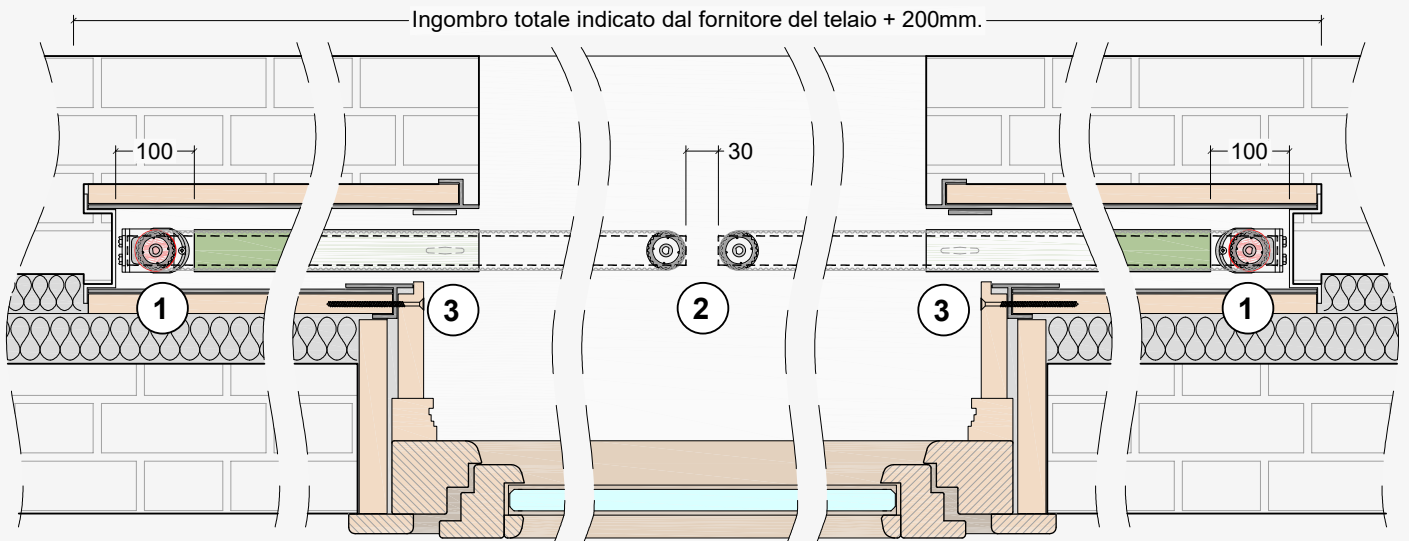

Application on double-door sliding counter frame

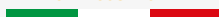

SL120 - ELECTRICAL CONNECTIONS

CSG2 electronic board and power supply unit in PT5 junction box, Dead man control

The electronic board is remotely located in a PT5 junction box measuring 160x130x70 mm, which must be positioned inside the building. The recommended distance between the junction box and the window compartment is 5m. By accessing the electronic board, you can check the wiring and set the control parameters easily and at any time. The electronics, made entirely in Italy, are environmentally friendly and comply with Low-Energy standards, consuming energy only during movement and remaining off at other times. In addition, the “man present” control makes the automation safe, and the 230Vac “roller shutter type” connection allows it to be controlled by any home automation system, without the need for additional interfaces.

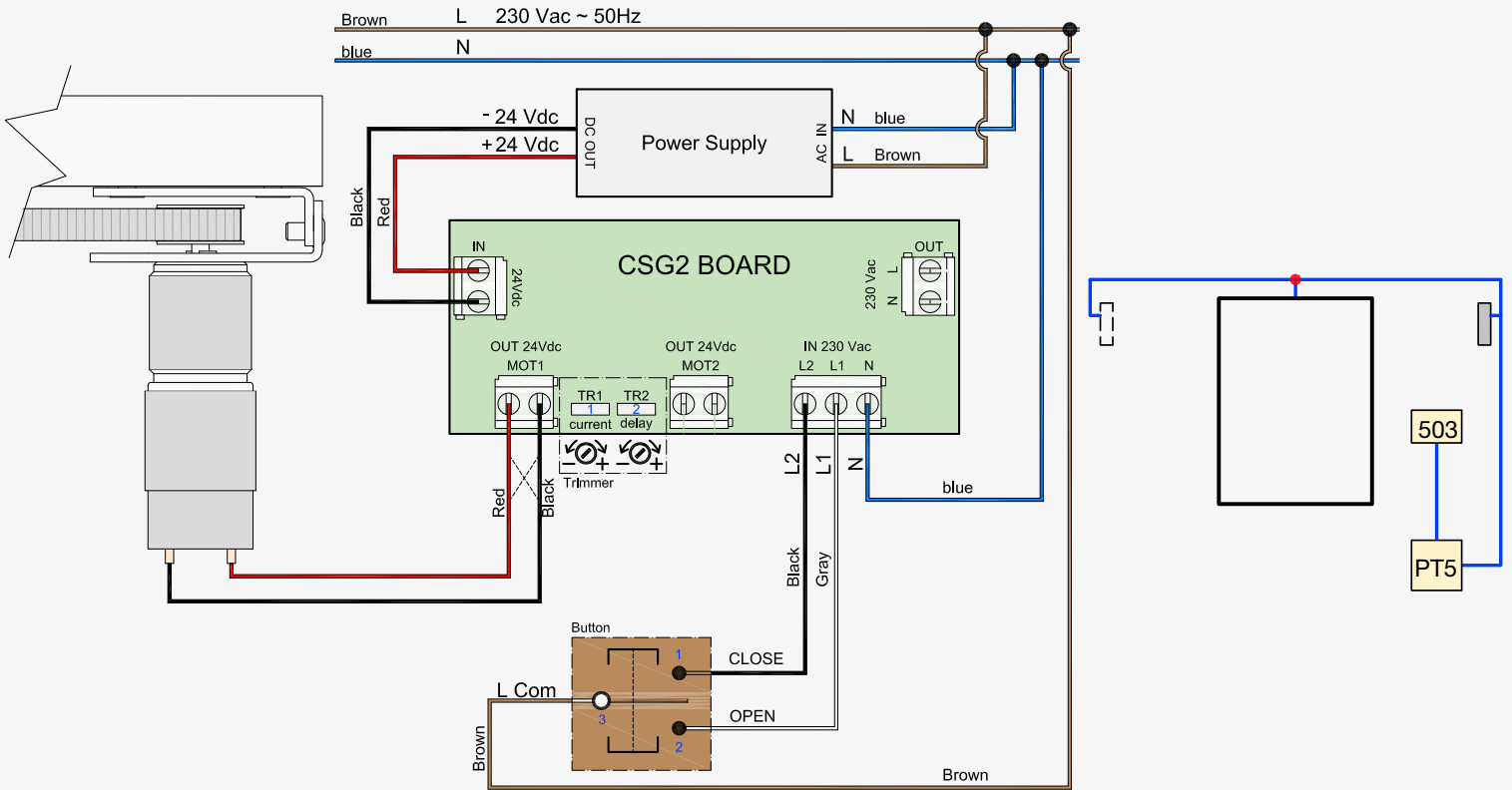

Electrical preparation

Cable outlet on rebate mullion for single-sash shutters, central for double-sash shutters

Cables 2x1.5mmq (± 24Vdc) in flush-mounted cable duct min. diameter 16 mm.

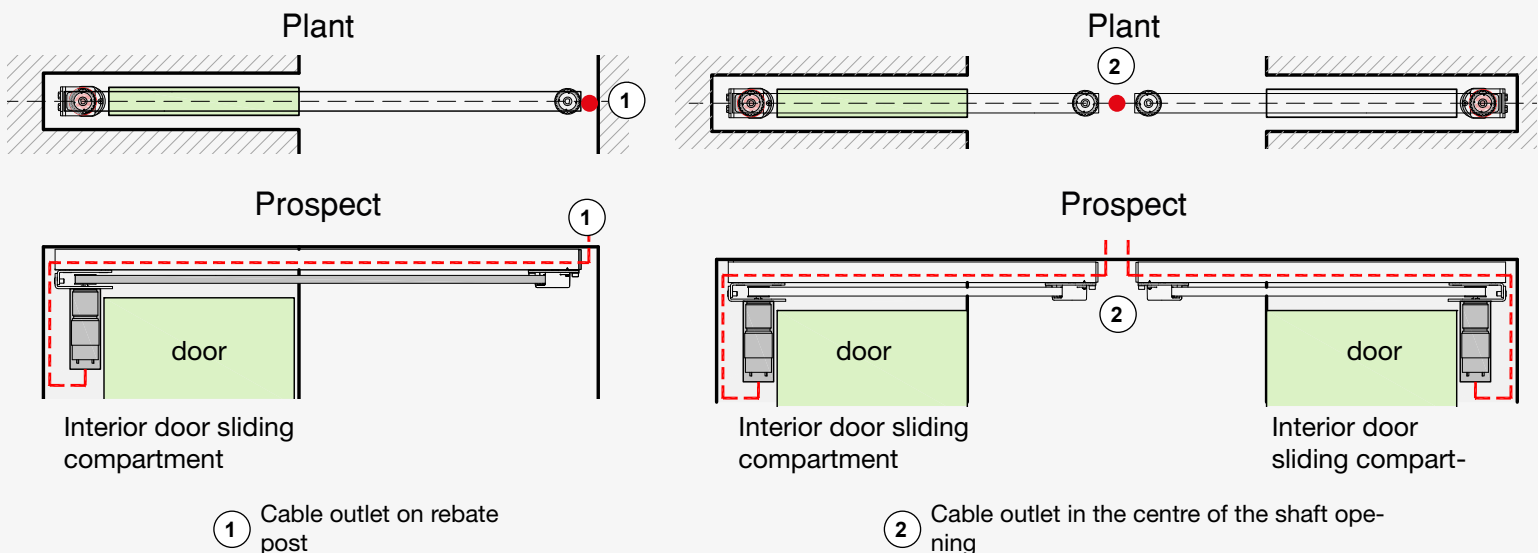

HOME AUTOMATION COMPATIBILITY

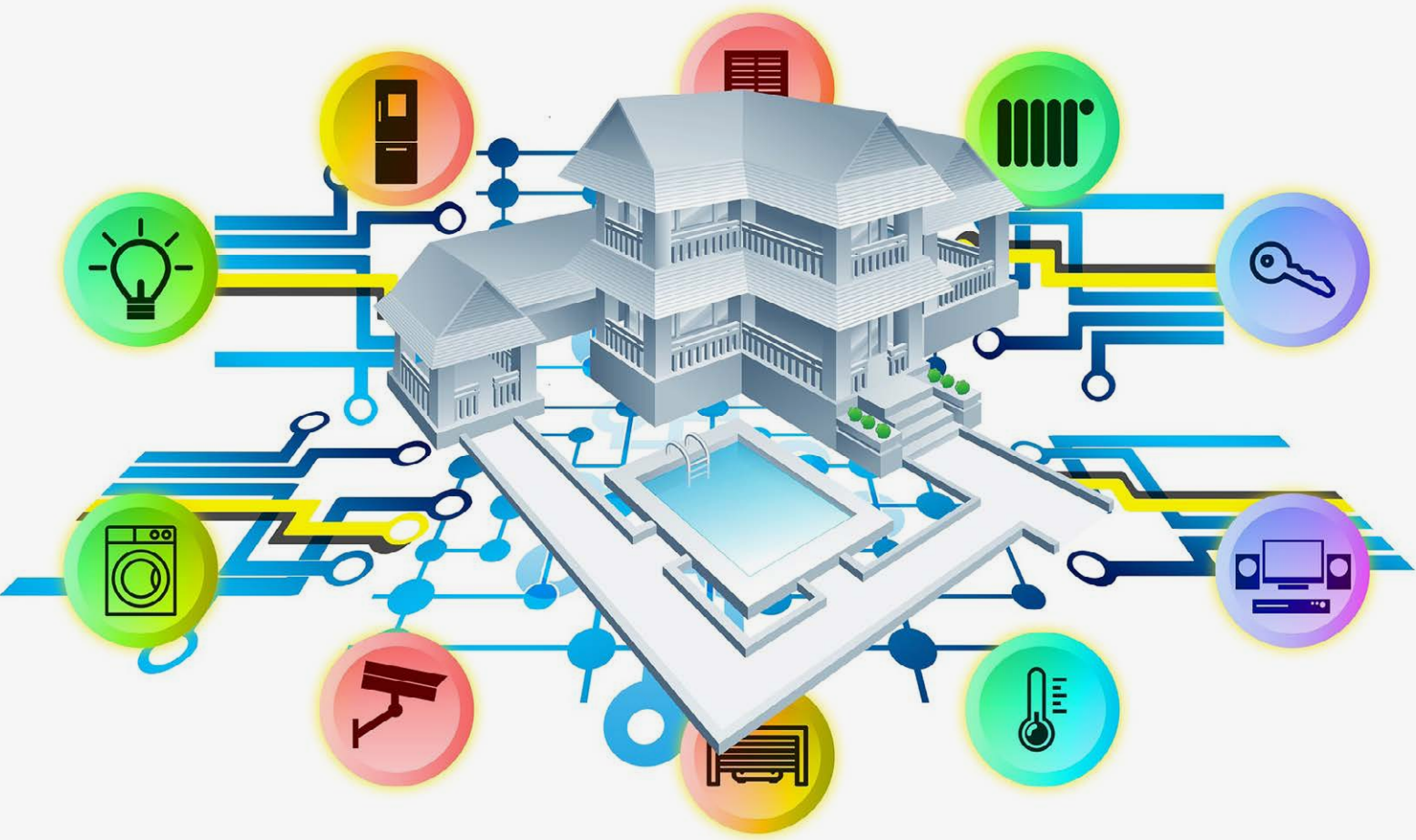

Compatibility with traditional and smart home wi-fi systems is a central aspect of the design of all CHIAROSCURO automations. The 'dead man' control guarantees the safety of the automations and the 230Vac 'roller shutter type' connection allows easy and fast interaction with any home automation system, with no need for additional interfaces. It is advisable to

set the operating time of the Home automation module with a safety margin of 5-10 seconds more than the actual operating time. To prevent possible damage, we suggest disabling the partial opening functions in percentage terms, allowing the user only the basic functions "fully open" or "fully closed". Should the user wish to place the leaves in partial opening positions, it will be necessary to integrate the home automation system with wind sensors to ensure safety. Our electronic boards, manufactured entirely in Italy, are ecological and comply with Low-Energy standards: they only consume energy during movement and remain inactive at other times.



SL120 - Measurement module

SL120 - Tick the box identifying the type of shutters

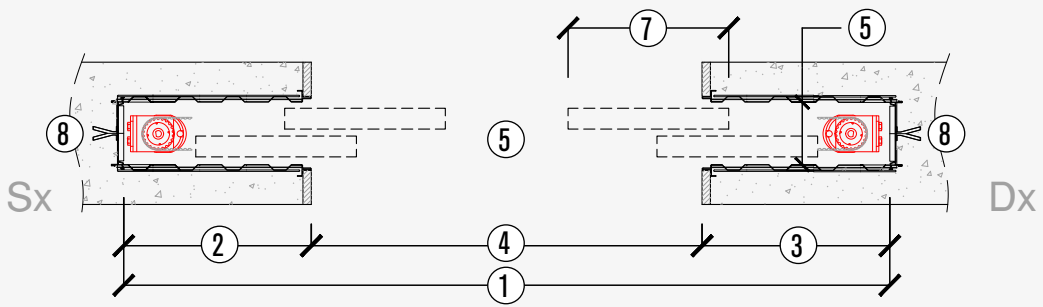
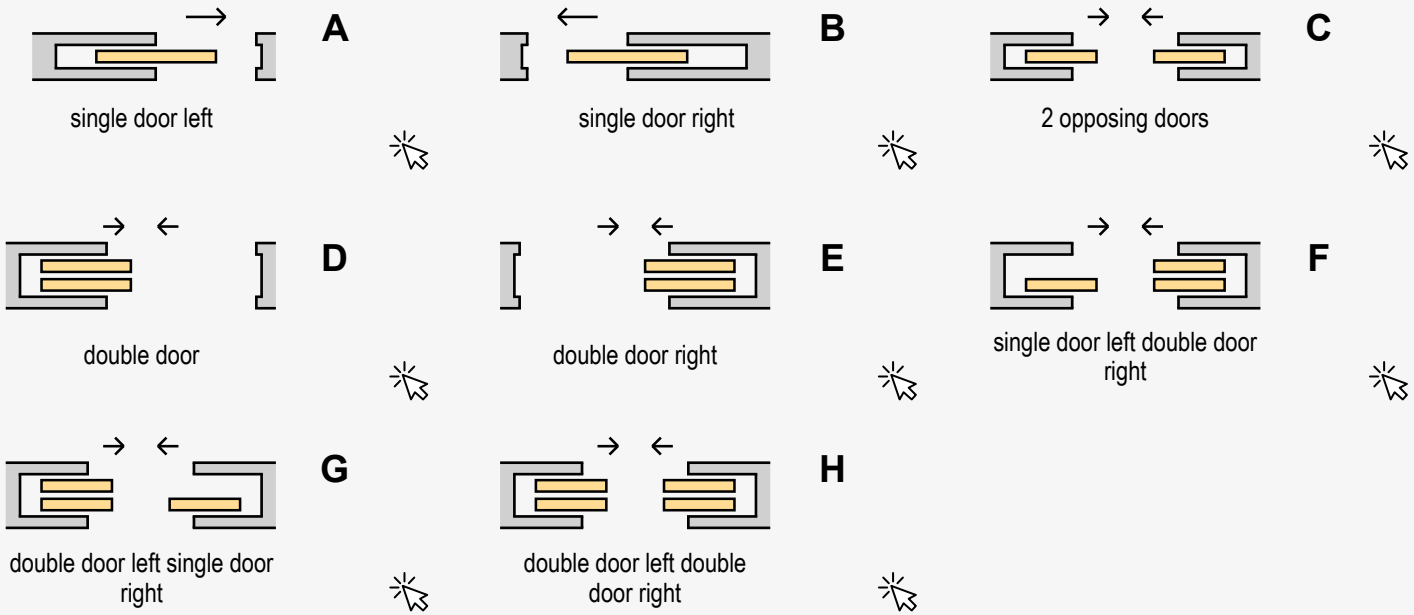



Compilation of measures

Rif.	Description of fee required	Group 1	Group 2	Group 3
N°	Specify quantity			
1	Total useful internal dimension			
2	Usable depth of left casing compartment (if present)			
3	Usable depth of right casing compartment (if present)			
4	Compartment width			
5	Useful internal box width (minimum 60 mm)			
6	Compartment height			
7	Single door size and weight (max. 200kg)			
8	Preferential position of the motor in relation to the doors			
	Cable length (5 metres by default) (desired amount of cable for each automation)			

SL120 - Measurement module

Specify casing type

Brand	Model	Tailored
		<input type="checkbox"/>

Tick if frame is tailored

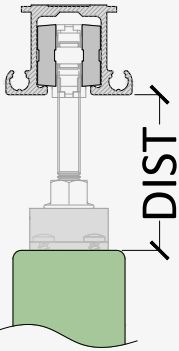

Specify distance between sash and track

Recommended sash/rail distance specification 35mm. (Min. 30mm. Max. 40mm.)

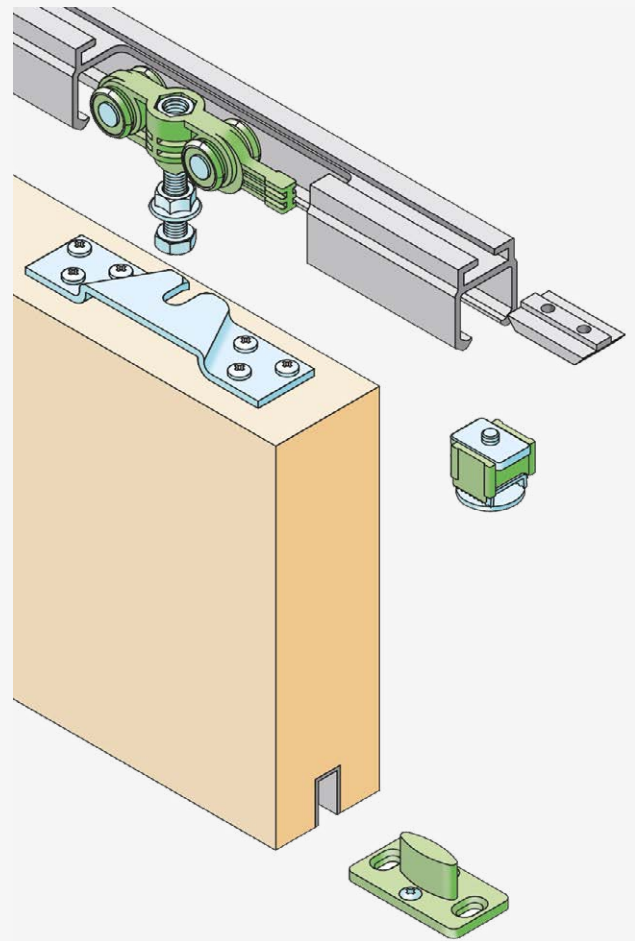
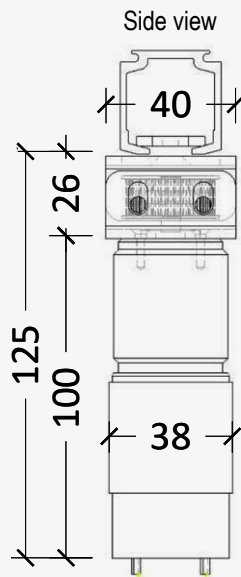
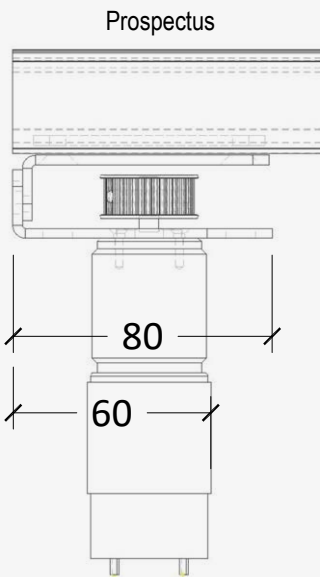
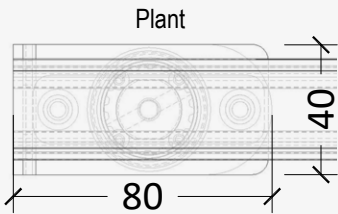

Tick the desired Track Kit or Track + Trolley Kit

Max load track 150 kg	Track kit + trolley capacity 150 kg
<input type="checkbox"/>	<input type="checkbox"/>



To be filled in if you use your own track



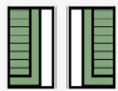

Marca	Modello	portata	Dimensioni

SL120 SLIDING DOOR AUTOMATION

SL120 AUTOMATION , MOTOR BLOCK AT END OF TRACK FACING DOWNWARDS

	Article	Description
	5097	SL120.2A-230V-STD Run-Automaz. For single sliding shutter, right or left, Load capacity 150Kg-L compartment 800-3000mm
	5098	SL120.1A-230V-STD Run-Automaz. For double-sliding shutter, Load capacity 150Kg+150Kg-L compartment 400-1500mm

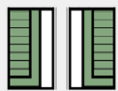

SL120 AUTOMATION , MOTOR BLOCK AT THE BEGINNING OF THE TRACK FACING UPWARDS

	Article	Description
	5109	SL120.2A-230V-STD Run-Automaz. For single sliding shutter, Load capacity 150Kg-L compartment 800-3000mm
	5110	SL120.1A-230V-STD Run-Automaz. For double-sliding shutter, Load capacity 150Kg+150Kg-L compartment 400-1500mm

ACCESSORI MECCANICI

	Article	Description
	5049	PT80-Monorail, 2000mm bar, portata 80Kg
	5050	PT80-Monorail, 3000mm bar, portata 80Kg
	5051	PT80-Monorail, barra 4000mm, portata 80Kg
	5052	PT80-Monorail, barra 6000mm, portata 80Kg
	5066	PT80-Set of trolleys for 1 door, load capacity 80 kg, stainless steel
	5088	PT80-Set of trolleys for 1 door, load capacity 80 kg
	5053	PT120-Monorail, 2000mm bar, load capacity 120Kg
	5054	PT120-Monorail, 3000mm bar, load capacity 120Kg
	5055	PT120-Monorail, 4000mm bar, load capacity 120Kg
	5056	PT120-Monorail, 6000mm bar, load capacity 120Kg
	5089	PT120-Set of trolleys for 1 door, load capacity 120 kg, STAINLESS STEEL
	5108	PT-Bottom guide overlapping doors
	1366	SL-Set for telescopic system 1+1, load capacity 75+75Kg
	1367	SL-Set for telescopic system 1+1+1, load capacity 50+50+50Kg
	5102	SL-Traction plate upper linkage, load capacity 150Kg
	5559	SL-Track coupling plate PT80/120 removable, load capacity 150Kg

ELECTRONIC ACCESSORIES

	Article	Description
	2213	EWSCE230 RadioReceiver terminal block 230V-number 01 automation
	2214	WSETX1 1ch radio control with magnetic wall mount
	2215	WSETX16 16ch radio remote control with magnetic wall mount

Master data request

COMPILATION BY THE APPLICANT

Contact person	PERSON OF REFERENCE COMMITTEE (surname first name)	TELEPHONE NUMBER
	<input type="text"/>	<input type="text"/>
	EMAIL ADDRESS	TAX CODE
	<input type="text"/>	<input type="text"/>

Company Data	COMPANY NAME	VAT NUMBER		
	<input type="text"/>	<input type="text"/>		
	ADDRESS	MUNICIPALITY	PROV	POSTcode
	<input type="text"/>	<input type="text"/>	<input type="text"/>	<input type="text"/>
	EMAIL PEC	SDI CODE		
	<input type="text"/>	<input type="text"/>		

Site References	SITE REFERENCE	TELEPHONE NUMBER
	<input type="text"/>	<input type="text"/>
	ADDRESS	<input type="text"/>
	<input type="text"/>	<input type="text"/>

Pursuant to art. 13 and 23 of Legislative Decree no. 196/2003, by signing this form, I authorise the processing of my personal and company data in the manner and within the limits set out in the information sheet pursuant to art. 13 of Legislative Decree no. 196/2003

I AGREE	DATE	SIGNATURE
<input type="checkbox"/> ✎	<input type="text"/>	<input type="text"/>

Conditions of Sale	<p>The Conditions of Sale set out on pages 07 - 08 - 09 of the following form govern the purchase contract between "Chiaroscuro Sas" - hereinafter referred to as the "Seller" and the customer for the purchase of products. The customer declares that he/she knows and unconditionally accepts the General Conditions of Sale and that he/she fulfils all the obligations provided for therein towards the Seller. For this reason, the Client is obliged to read them carefully, printing and conserving them, in accordance with the provisions of Art. 50 et seq. of Legislative Decree No. 206/05. The Seller shall be authorised to amend or supplement these general sales conditions at any time, also in consideration of any regulatory changes, without having to give prior notice thereof.</p>
	<p>I HAVE READ THE GENERAL TERMS AND CONDITIONS</p> <p><input type="checkbox"/> ✎</p>

General Terms and Conditions of Sale and Delivery

Article 1 - Definitions

“Customer” means the person who has placed an order for the Goods; “Goods” means the Goods ordered by the Customer and sold and/or distributed by the Company as specified in the order acceptance and/or invoice; “Invoice” means the document sent by the Company to the Customer requesting payment for the Goods and setting out and confirming the terms and conditions relating to the Contract

“Offer-and” means offers of Products by the Company; “Price” means the consideration for the Products; “Contract” means a contract for the supply of Products by the Company to the Customer which is governed by these terms and conditions, the Company’s terms and conditions and the Company’s terms and conditions confirming the order for Products ordered or requested by the Customer.

Unless otherwise provided for or specified by the Company, these general terms and conditions shall also govern future sales relationships that may arise between the parties.

Article 2 - Products - Offers - Catalogues

2.1 The Company’s offers are valid for a maximum period of 30 days from the date they are sent.

2.2 The sending of catalogues by Chiaroscuro Sas does not constitute an offer and the same may be freely modified by Chiaroscuro Sas at any time without notice. The data and technical characteristics contained in the catalogues are indicative and not binding for Chiaroscuro Sas.

2.3 The Products are supplied on the terms set forth in these General Conditions as well as on the terms and conditions specified in the contract and/or in the invoices and/or in any document coming from the Company, to the exclusion of any other term or condition set or proposed or requested by the customer. Any variation or amendment of these General Conditions and the terms and conditions specified in the Contract or manifested by the Company in its invoices or in any documents originating from the Company shall be accepted in writing by the Company.

2.4 No order and/or no request and/or no contractual proposal and/or no indication of price from the Customer, even if collected by the Company’s agents or nominees, shall be binding on the Company unless expressly accepted by the Company.

2.5 The supply shall be carried out according to the terms indicated by the Company in its invoices or in any case in the Company’s source documents.

Article 3 - Delivery, right of ownership and risks

3.1 Delivery will take place according to the terms, conditions and procedures agreed upon and indicated when the order is accepted by the Company.

3.2 The loading of the Products for transport shall entail the identification of the goods and the simultaneous transfer of risks.

3.3 Unless otherwise agreed in writing, the costs and charges for transport or delivery shall be borne by the Customer and shall be indicated separately on the Company’s invoice.

3.4 The Customer acknowledges that, for manufacturing reasons, the delivery of the Products by the Company may be split or delayed, without this entailing any liability for the Company.

3.5 The delivery dates and terms are to be regarded as indicative and not binding on the Company, which shall not be liable for any delay in delivery due to any cause whatsoever. No claim for damages of any kind may be made against the Company in the event of delay.

3.6 Goods shall therefore travel at the cost, risk and peril of the Buyer, in the case of carriage carriage ex works in accordance with Incoterms 2010. Unless otherwise agreed, the company shall determine the type of shipment, the transport route and the carrier on behalf of the customer. The company reserves the right to carry out partial executions or deliveries of orders, issuing a separate invoice for each delivery: in this case, all partial deliveries shall be invoiced independently and the payment terms shall run from the date of each invoice; the customer may not defer payment for partial deliveries until the deliveries relating to the original order have been completed.

3.7 Transport insurance can only be taken out at the Customer’s request, at the Customer’s expense, and shall be stated in the order confirmation.

3.8 The delivery may be suspended by Chiaroscuro Sas in case of non-payment of any advance by the Customer or even of a single instalment in case of payment by instalments, until all the data and technical and administrative information useful for the correct fulfilment of the order and/or until Chiaroscuro sas has received communication of the delivery or of the opening of the letter of credit issued by the confirming or warning Bank, as the case may be.

Article 4 - Acceptance of products

4.1 Unless the Customer, at the time of delivery and in any event no later than 8 days thereafter, notifies the Company in writing of the presence of any defects in the Products, the Products shall be deemed accepted without reservation by the Customer.

4.2 In case of confirmation by the Company of apparent defects and/or non-conformity, the Customer may obtain, always at the discretion of Chiaroscuro Sas, the free replacement of the goods, or the reimbursement of the agreed price, as paid. The payment of indemnities of any kind and compensation for damages of any nature and entity is in any case excluded.

4.3 Returned goods shall only be accepted by the Company with prior written agreement and authorisation as per the procedure, in any case for new goods and complete with original packaging.

4.4 Returns must be accompanied by the appropriate transport document, indicating the Company’s written return authorisation and the quality and quantity of the returned goods. Returns shall not be considered accepted by the Company unless they are made in the manner described above and, in particular, the taking delivery of goods at the Company’s headquarters or warehouses shall not be considered as acceptance of returns.

4.5 Excluded from the return procedure and therefore returned to the client, at his expense, are goods: - Not identifiable by the corresponding lot number that have undergone tampering and/or unauthorised modifications by the client; - Not accompanied by the return authorisation number; - For which the client is not able to show the document from which the supply by Chiaroscuro Sas transport document and/or invoice is shown.

The Customer shall always bear the risk and costs of the return. In case of confirmation by the company of the apparent defects and/or non-conformity, the customer can obtain, always at the discretion of Chiaroscuro Sas, the free replacement of the goods, or reimbursement of the agreed price, as paid. is in any case excluded the payment of indemnities of any kind and compensation for damages of any nature and entity.

Article 5 - Product Information - Replacement - Patents, Trade Marks and Distinctive Signs - Guarantees

5.1 The Company fulfils its obligation to provide information on the products by means of the technical documentation and the user and maintenance manuals that accompany them. it is the customer’s responsibility to provide information on the conditions of use and safety to its customers. It is also specified that the technical documentation and the user and maintenance manuals cannot cover all cases of installation and use of the products; it is therefore the customer’s care and responsibility to contact the Company should they require additional information.

5.2 The Customer is aware that the Chiaroscuro Sas branded products are covered by patents and are the subject of know-how and design constituting the exclusive property of Chiaroscuro Sas according to Legislative Decree n.30/2005 and subsequent amendments (Industrial Property Code). It is expressly forbidden for the Customer to violate these rights of Chiaroscuro Sas and in any case to remove, suppress or in any case alter trademarks and other distinctive signs or abbreviations of any kind affixed to the products, as well as it is forbidden to affix new ones of any kind. Any form of reproduction or use of the Chiaroscuro Sas trademark and any other distinctive sign on the products is therefore forbidden.

5.3 The guarantee as provided for in this clause applies to products sold by Chiaroscuro Sas from the date of entry into force of these general sales conditions.

5.4 The Company therefore guarantees that the products have no defects attributable to the materials used. design and manufacture.

5.5 In the event of product defects recognised by the Company and attributable to materials, design and manufacture, the Company shall replace or repair the products. In the event of replacement or repair of products under warranty, the warranty period for new or repaired products shall expire with reference to the end of the original supply.

5.6 Products sold by Chiaroscuro Sas are guaranteed within the terms provided for by the Civil Code, starting from the date of the transport document or, failing this, from the date of the sales invoice.

5.7 Products deemed to be defective shall be shipped at the customer’s expense to: Chiaroscuro Sas, Corso General cantore n°23 38061 Ala (TN), Italy. The company has the right to ask the customer for a copy of the purchase invoice of the products. If the products returned under warranty, following Chiaroscuro Sas’ assessment, are found to be defective, the latter shall replace or repair them free of charge. The shipping costs of the replacement or repaired products shall be borne by Chiaroscuro Sas.

5.8 If, following the Company’s assessment, the product does not prove to be defective in relation to the materials used, design and manufacture, the Company shall automatically arrange for its repair or the return of the unrepaired material. Once the operations have been completed, the Company shall inform the Customer in writing, including by e-mail, of the state of the product and of any costs generated. The product shall be returned within one month from the date of receipt of the communication. In the case of dedicated shipment, shipping costs shall be borne by the Customer.

5.9 The guarantee does not apply in the following cases

- products damaged during transport;
- choice, installation, commissioning and use of the product not in compliance with the instructions contained in the technical documentation and in the use and maintenance manuals supplied with the product;
- incorrect installation, use and maintenance due to negligence and carelessness on the part of the Customer;
- defects resulting from force majeure, such as natural phenomena or unforeseeable events, or due to phenomena or events or facts not attributable to the product;
- use of the product in combination with inappropriate products and/or components;
- carrying out of modifications and/or disassembly of the product, in the absence of formal authorisation by the Company;
- failure to comply with the instructions concerning the use of software applications not included in the product and governing its operation;
- damage resulting from fire, accidents, unforeseeable events or other circumstances not attributable to Chiaroscuro Sas;
- damage occurring during the period of non-payment by the Customer. The guarantee does not cover costs and expenses related to the replacement of materials subject to consumption and/or wear and tear, to the activities of disassembly and re-installation of the product, to ordinary maintenance activities which remain the responsibility of the Customer.

This guarantee absolves Chiaroscuro Sas of all responsibilities in relation to the products supplied. Chiaroscuro Sas is therefore not responsible in relation to costs, claims, losses and/or direct damages or damages caused to the Customer and third parties by the choice, installation and use of the products. The Customer is responsible for the suitability of the product requested for the use for which it is intended and is also responsible, to all effects of reason and law, for informing its Customers. The Company reserves the right to replace, in whole or in part, the Products that are the subject of the order upon prior notice to the Customer.

Article 6 - Customer Obligations and Forfeitures

6.1 The Customer shall use the Products properly and give the Company all reasonable information and facilities to enable the Company to perform its contractual obligations.

6.2 The Customer shall in any event comply with all statutory and contractual requirements applicable to it.

6.3 The Customer may not, however, suspend or delay payments in case of dispute, defect of the Products, complaint or delay in the delivery of the Products by Chiaroscuro Sas

Article 7 - Price and Payment

7.1 Payment shall be made in full at the time of delivery of the Products, or at such other time as may be agreed and indicated by the Company and/or set out in the invoice and/or indicated in the order acceptance and/or in the supply and sale contract.

7.2 The Price of the Products shall be the price indicated by the Company and in any case, the price indicated in the invoice and/or in the contract by the Company.

7.3 Chiaroscuro Sas reserves the right to modify without notice the agreed payment conditions whenever the conditions that motivated them change, or in the presence of customer orders that present a high financial risk for the Company, or in the presence of customers who do not respect the agreed supply conditions.

Regardless of what is indicated in the order confirmation, payment shall in any case be understood to be made at the premises of Chiaroscuro Sas. the issuance of bills of exchange, cheques or other payment instruments by the Customer does not constitute payment, nor does it determine a change in the place of execution or entail novation of the original obligation. In any case, all costs for the issuance of such bills of exchange, cheques or other payment instruments as well as the related bank charges shall be borne by the Customer.

7.4 Failure to pay within the agreed term shall entail the application of the interest rate provided for by Article 5 of Legislative Decree No. 231 of 09/10/2002 (as transposed by European Parliament and Council Directive 2000/35/EC and by the Vienna Convention of 11/04/1980 ratified by the Italian State with Law No. 765/1985) and subsequent amendments and updates, without prejudice to any further damages. In the event of a delay in payment, the Customer shall in any case owe the Company any losses due to the exchange. The Customer shall not be entitled to make any claims or raise any objections against the Company until after having paid for the purchased goods.

7.5 In case of non-fulfilment and/or non-payment, Chiaroscuro Sas shall in any case have the right to suspend and block all shipments in progress, all supply orders in progress in case of payment irregularities, without any notice or right to compensation of any damage in favour of the Customer

7.6 The parties agree that any discounts and premiums granted to the Customer shall be conditional on the Customer actually paying the purchase invoices to the Company within the agreed terms. Unpaid invoices shall not determine or entitle the Customer to any additional discount, premium or compensation;

Article 8 Liability - Severability Clause - Penal Clause

8.1 The Company shall not be liable for any loss or damage suffered by the Customer as a result of failures or defects in the Products unless such failures or defects are attributable to the Company's wilful misconduct or negligence as ascertained by a final judgment of the competent Italian judicial authority.

8.2 Furthermore, the Company shall not be liable to the Customer for any loss of profit or for any other indirect or consequential loss or damage resulting either from breach of contract or from non-contractual or pre-contractual liability of the Company.

8.3 In no event shall the Company be liable for any loss or damage, direct or indirect, caused to the Customer by Third Party Products, in respect of which the liability of the third party manufacturer under law shall remain unaffected.

8.4 Pursuant to and for the purposes of Article 1456 of the Italian Civil Code, failure to pay or delayed payment, even in part, by the Customer shall allow the Company to consider the existing contract or any orders or proposals to purchase that have been accepted and/or finalised terminated pursuant to Article 1456 of the Italian Civil Code, without prejudice to the right to compensation for damages suffered and suffered and without prejudice to the right to retain the advances and any sums already collected, without prejudice to compensation for any greater damages.

8.5 In the event of cancellation of a confirmed order or failure to collect the Products, the Customer shall be required to pay a penalty equal to 30% (thirty per cent) of the value of the cancelled and/or not collected Products, without prejudice to the right of Chiaroscuro Sas to compensation for any greater damage.

Article 9 - Force Majeure

9.1 The Parties shall not be liable for delay in the performance of their obligations under these General Terms and Conditions as well as the Contract if such delay is caused by circumstances beyond their reasonable control. The Party delayed due to force majeure shall be entitled to a reasonable extension of time for the performance of such obligations.

Article 10 - Confidentiality

10.1 Each Party shall treat as confidential, and shall treat it with at least the same standard of care as it treats its own confidential information, all information obtained by the other under the Agreement and marked "confidential" (or similar expression) or otherwise of a confidential nature to either Party. Article 11 - Communications

11.1 All communications between the Parties shall be in writing and sent to the address of the addressee indicated in the Contract or to the registered office of the addressee or to any other address indicated by the addressee.

11.2 Such communications may be sent by registered letter and e-mail pec adme@pec.chiaroscuro.eu and shall be deemed received upon delivery if delivered by hand, 48 hours after dispatch if sent by registered letter, at the time of transmission if sent by telex or telefax.

11.3 Communications affecting the validity or existence of the Contract shall be exclusively hand-delivered or sent by registered letter with acknowledgement of receipt and e-mail pec adme@pec.chiaroscuro.eu.

Article 12 - Applicable Law, Jurisdiction and Jurisdiction

12.1 This Contract shall be governed by and construed in accordance with the laws of Italy and shall be subject exclusively to Italian jurisdiction.

12.2 The Court of Rovereto (TN) shall have exclusive jurisdiction over any dispute arising from the supply, with the exclusion of any derogation for reasons of connection or continece of cause, even if the terms of payment have been indicated by means of bank receipts, drafts, assignments.

Article 13 . Provisions on the protection of individual data

13.1 Pursuant to current legislation for the protection of personal data, the customer is informed that personal data pertaining to him/her are entered into the Company's database, as this is necessary for the proper performance of the contractual relationship and for the fulfilment of certain legal provisions, as well as for statistical, commercial, marketing, promotional, credit protection, management and assignment purposes.

13.2 The purchaser's personal data are processed by means of automated and paper-based instruments by authorised parties, with the use of security measures to guarantee confidentiality. The customer's personal data may be communicated to Entities, Group companies, credit recovery companies or companies, consortia and associations for commercial, market research and marketing purposes.

13.3 11 The data controller is the Company, which the Customer may contact in order to exercise its rights under the law. To this end, the Purchaser is informed that he/she may at any time have access to his/her personal data, request that they be updated, corrected or deleted and/or oppose their processing



Two minds, one mission: to create excellence in shutter automation!



Chiaroscuro SAS di Girelli Marco & C
C.So General Cantore n°23
38061 Ala (TN) - Loc. Serravalle
Tel 0464 424 715 Whatsapp 329 5944433
www.chiaroscuro.eu info@chiaroscuro.eu

www.chiaroscuro.eu

